





 @AlphaEnergyStorageSystem 
  @AlphaESS 
  @alpha\_ess 
  @AlphaESS 
  www.alpha-ess.com



#### Alpha ESS Co., Ltd.

 +86 513 806 068 91  
 info@alpha-ess.com  
 www.alpha-ess.com  
 JiuHua Road 888, High-Tech Industrial Development  
 Zone 226300 Nantong City, Jiangsu Province





#### Alpha ESS Suzhou Co., Ltd.

 +86 512 6828 7609  
 info@alpha-ess.com  
 www.alpha-ess.com  
 Building 10-A, Canal Town Industrial Park,  
 99 Taihu E Rd, Wuzhong District, Suzhou 215000





#### Alpha ESS Europe GmbH

 +49 610 3459 1601  
 europe@alpha-ess.de  
 www.alpha-ess.de  
 Paul-Ehrlich-Straße 1a 63225 Langen



#### Alpha ESS Australia Pty. Ltd.

 +61 1300 968 933  
 australia@alpha-ess.com  
 www.alpha-ess.com.au  
 Unit 1, 2 Ralph Street Alexandria NSW 2015



#### Alpha ESS Italy S.r.l.

 +39 599 239 50  
 info@alpha-ess.it  
 www.alpha-ess.it  
 Via Loda,17-41013 Castelfranco Emilia(MO)



#### Alpha ESS Korea Co., Ltd

 +82 64 721 2004  
 korea@alpha-ess.com  
 2F, 19-4, Nohyeong 11-gil, Jeju-si, Jeju-do,  
 Republic of Korea

#### Alpha ESS UK Co., Ltd

 uk@alpha-ess.com  
 Drake House, Long Street, Dursley, gl11 4hh

#### Alpha ESS International Pte. Ltd.

 Singapore@alpha-ess.com  
 Blk 55 Ayer Rajah Crescent #01-01, Singapore  
 139949

#### Alpha ESS USA, Inc.

 USA@alpha-ess.com  
 638 S Ahwanee Ter Sunnyvale, California,  
 94085 United States of America

# INSTALLATION MANUAL ENERGY STORAGE SYSTEM (ESS) SMILE-T10-HV

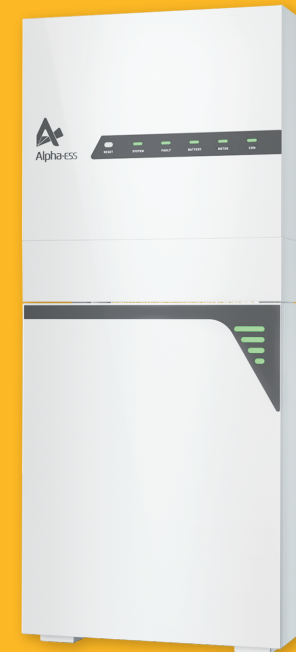

## Copyright Statement

This manual is under the copyright of Alpha ESS Co., Ltd. with all rights reserved. Please keep the manual properly and operate in strict accordance with all safety and operating instructions in this manual. Please do not operate the system before reading through the manual.

# CONTENT

<b>01</b>	<b>INFORMATION ON THIS DOCUMENT</b>	<b>01</b>
1.1	Content and Structure of this Document	01
1.2	Target Group	01
1.3	Levels of Warning Messages	01
1.4	Nomenclature	02
<b>02</b>	<b>SAFETY</b>	<b>03</b>
2.1	Intended Use of the Inverter	03
2.2	Safety Precaution for Battery Pack	03
2.3	Important Safety Instructions	05
2.4	Symbols on the label	08
<b>03</b>	<b>PRODUCT INTRODUCTION AND APPLICATION SCENARIOS</b>	<b>10</b>
3.1	Inverter Description	10
3.2	Battery Pack Description	12
3.3	Application Scenarios	13
<b>04</b>	<b>STORAGE</b>	<b>15</b>
4.1	Inverter Storage	15
4.2	Battery Storage	15
<b>05</b>	<b>UNPACKING</b>	<b>16</b>
5.1	Checking the Outer Packing	16
5.2	Scope of Delivery	16
<b>06</b>	<b>MOUNTING</b>	<b>18</b>
6.1	Requirements for Mounting	18
6.2	Preparing Tools and Instruments	20
6.3	Mounting the Battery Pack and Inverter	21
<b>07</b>	<b>ELECTRICAL CONNECTION</b>	<b>28</b>
7.1	Overview of the Connection Area	29
7.2	Preparing Cables	30
7.3	Connecting Additional Grounding	31
7.4	AC Connection	31
7.5	Communication Connection	38

7.6 PV Connection .....	39
7.7 Battery Power Connection .....	40
7.8 Mounting the Cable Cover .....	40
7.9 Battery Pack Expansion Connection .....	41
<b>08</b> <b>WIFI SETTING</b> .....	<b>43</b>
8.1 Download and Install the Application .....	43
8.2 Overview of Functions for Installer Account .....	44
8.3 WiFi Module Setting .....	45
<b>09</b> <b>COMMISSIONING</b> .....	<b>48</b>
9.1 Checking Before Power-On .....	48
9.2 Check the Running State .....	48
9.3 Powering Off the Product .....	49
<b>10</b> <b>MAINTENANCE AND TROUBLESHOOTING</b> .....	<b>50</b>
10.1 Routine Maintenance .....	51
10.2 Troubleshooting .....	52
<b>11</b> <b>UNINSTALLATION &amp; RETURN</b> .....	<b>56</b>
11.1 Removing the Product .....	56
11.2 Packing the Product .....	56
11.3 Disposing of the Product .....	56
<b>12</b> <b>SPECIFICATION</b> .....	<b>57</b>
12.1 Datasheet of Hybrid Inverter SMILE-T10-HV-INV .....	57
12.2 Datasheet of Battery Pack SMILE-BAT-8.2PH .....	59

## 01 Information on this Document

### 1.1 Content and Structure of this Document

This document is valid for product of SMILE-T10-HV system which include inverter SMILE-T10-HV-INV, battery pack SMILE-BAT-8.2PH.

This document describes the mounting, installation, commissioning, configuration, operation, troubleshooting and decommissioning of the product as well as the operation of the product user interface.

Observe all documentation that accompanies the product, keep them in a convenient place and available at all times.

Illustrations in this document are reduced to the essential information and may deviate from the real product.

### 1.2 Target Group

This document is intended for qualified persons and end users. Only qualified persons are allowed to perform the activities marked in this document with a warning symbol. Tasks that do not require any particular qualification are not marked and can also be performed by end users. Qualified persons must have the following skills:

- ★ Knowledge of how an inverter works and operates
- ★ Training in how to deal with the dangers and risks associated with installing and using electrical devices, batteries and systems
- ★ Training in the installation and commissioning of electrical devices and systems
- ★ Knowledge of the applicable standards and directives
- ★ Knowledge of and compliance with this document, including all safety precautions
- ★ Knowledge of and compliance with the documents of the battery manufacturer, including all safety precautions

### 1.3 Levels of Warning Messages

#### DANGER

DANGER indicates a hazardous situation which, if not avoided, will result in death or serious injury.

#### WARNING

WARNING indicates a hazardous situation which, if not avoided, could result in death or serious injury.

#### CAUTION

CAUTION indicates a hazardous situation which, if not avoided, could result in minor or moderate injury.

**NOTICE**  
 NOTICE indicates a situation which, if not avoided, can result in property damage.

**i**  
 INFORMATION provides tips which are valuable for the optimal installation and operation of the product.

**1.4 Nomenclature**

Complete designation	Designation in this document
SMILE-BAT-8.2PH (INDOOR)	Battery Pack (INDOOR)
SMILE-BAT-8.2PH (OUTDOOR)	Battery Pack (OUTDOOR)
SMILE-T10-HV-INV (INDOOR)	Inverter (INDOOR)
SMILE-T10-HV-INV (OUTDOOR )	Inverter (OUTDOOR)
SMILE-T10-HV-INV with SMILE-BAT-8.2PH	Product

**02 Safety**

**2.1 Intended Use of the Inverter**

The inverter, the battery pack and the energy meters make up a system for optimization of self-consumption in a household. The inverter is equipped with two MPP trackers and converts the direct current from the PV array into grid-compliant three-phase current and feeds it into the utility grid. The Battery Pack is used for the intermediate storage of the energy.

The product is suitable for indoor and outdoor use.

The product must only be operated with PV arrays of protection class II in accordance with IEC 61730, application class A. The PV modules must be compatible with this product.

PV modules with a high capacity to ground must only be used if their coupling capacity does not exceed 1.0 µF.

All components must remain within their permitted operating ranges at all times.

Use this product only in accordance with the information provided in the enclosed documentation and with the locally applicable standards and directives. Any other application may cause personal injury or property damage.

Alterations to the product, e.g. changes or modifications, are only permitted with the express written permission of AlphaESS. Unauthorized alterations will void guarantee and warranty claims. AlphaESS shall not be held liable for any damage caused by such changes.

Any use of the product other than that described in the Intended Use section does not qualify as appropriate.

The enclosed documentation is an integral part of this product. Keep the documentation in a convenient place for future reference and observe all instructions contained therein. The type label must remain permanently attached to the product.

**2.2 Safety Precaution for Battery Pack**

**2.2.1 General Safety Precautions**

Over-voltages or wrong wiring can damage the battery pack and cause deflagration, which can be extremely dangerous.

All types of breakdown of the battery may lead to a leakage of electrolyte or flammable gas.

Battery pack is not user serviceable. High voltage is present in the device.

Read the label with Warning Symbols and Precautions, which is on the right side of the battery pack.

Do not connect any AC conductors or PV conductors directly to the Battery Pack which should be only connected to the Inverter.

Do not charge or discharge damaged battery.

Do not damage the Battery Pack in such ways as dropping, deforming, impacting, cutting or penetrating with a sharp object. It may cause a leakage of electrolyte or fire.

Do not expose battery to open flame.



## 2.2.2 Response to Emergency Situations

The Battery pack comprises multiple batteries that are designed to prevent hazards resulting from failures. However, AlphaESS cannot guarantee their absolute safety.

- ★ If a user happens to be exposed to internal materials of the battery cell due to damage on the outer casing, the following actions are recommended.
  - Inhalation: Leave the contaminated area immediately and seek medical attention.
  - Eye contact: Rinse eyes with running water for 15 minutes and seek medical attention.
  - Contact with skin: Wash the contacted area with soap thoroughly and seek medical attention.
  - Ingestion: Induce vomiting and seek medical attention.

If a fire breaks out in the place where the battery pack is installed, perform the following countermeasures:

- ★ Fire extinguishing media
  - Respirator is not required during normal operations.
  - Use FM-200 or CO2 extinguisher for battery fire.
  - Use an ABC fire extinguisher, if the fire is not from battery and not spread to it yet.
- ★ Firefighting instructions
  1. If fire occurs when charging batteries, if it is safe to do so, disconnect the battery pack circuit breaker to shut off the power to charge.
  2. If the battery pack is not on fire yet, extinguish the fire before the battery pack catches fire.
  3. If the battery pack is on fire, do not try to extinguish but evacuate people immediately.

### WARNING

There may be a possible explosion when batteries are heated above 150°C. When the battery pack is burning, it leaks poisonous gases. Do not approach.

- ★ Effective ways to deal with accidents
  - On land: Place damaged battery into a segregated place and call local fire department or service engineer.
  - In water: Stay out of the water and don't touch anything if any part of the battery, inverter, or wiring is submerged.
  - Do not use submerged battery again and contact the service engineer.

## 2.3 Important Safety Instructions

This section contains safety precautions that must be observed at all times when working on or with the product.

To prevent personal injury and property damage and to ensure long-term operation of the product, read this section carefully and follow all safety precautions at all times.

### DANGER

#### **Danger to life due to electric shock when live components or cables are touched**

High voltages are present in the conductive components or cables of the product. Touching live parts and cables results in death or lethal injuries due to electric shock.

- ★ Do not touch non-insulated parts or cables.
- ★ Disconnect the product from voltage sources and make sure it cannot be reconnected before working on the inverter or the Battery Pack.
- ★ After disconnection, wait 5 minutes until the capacitors have discharged.
- ★ Do not open the product.
- ★ Wear suitable personal protective equipment for all work on the product.

### DANGER

#### **Danger to life due to electric shock when live components or DC cables are touched**

When exposed to sunlight, the PV array generates high DC voltage which is present in the DC conductors. Touching the live DC cables results in death or lethal injuries due to electric shock.

- ★ Disconnect the inverter from voltage sources and make sure it cannot be reconnected before working on the device.
- ★ Do not touch non-insulated parts or cables.
- ★ Do not disconnect the DC connectors under load.
- ★ Wear suitable personal protective equipment for all work on the inverter.

### DANGER

#### **Danger to life due to electric shock from touching an ungrounded PV module or array frame**

Touching ungrounded PV modules or array frames results in death or lethal injuries due to electric shock.

- ★ Connect and ground the frame of the PV modules, the array frame and the electrically conductive surfaces so that there is continuous conduction. Observe the applicable local regulations.

**DANGER****Danger to life due to electric shock when touching live system components in case of a ground fault**

If a ground fault occurs, parts of the system may still be live. Touching live parts and cables results in death or lethal injuries due to electric shock.

- ★ Disconnect the product from voltage sources and make sure it cannot be reconnected before working on the device.
- ★ Touch the cables of the PV array on the insulation only.
- ★ Do not touch any parts of the substructure or frame of the PV array.
- ★ Do not connect PV strings with ground faults to the inverter.

**DANGER****Danger to life due to high voltages on the Battery Pack**

Lethal voltage is present at the pin connector for the power cable. Reaching into the pin connector for the power cable can result in lethal electric shock.

- ★ Do not open the Battery Pack.
- ★ Do not wipe over the Battery Pack with a damp cloth.
- ★ Leave the protective caps on the pin connectors for the batteries power connection until the inverter cables are connected to the Battery Pack.
- ★ Disconnect the product from voltage sources and make sure it cannot be reconnected before working on the inverter or the Battery Pack.

**WARNING****Risk of chemical burns from electrolyte or toxic gases**

During normal operation, no electrolyte can leak from the battery pack and no toxic gases can form. Despite careful construction, if the battery pack is damaged or a fault occurs, it is possible that electrolyte may be leaked or toxic gases formed.

- ★ Store the battery pack in a cool and dry place.
- ★ Do not drop the battery pack or damage it with sharp objects.
- ★ Only set the battery pack down on its back, i.e., on the side with the mounting lugs.
- ★ Do not open the battery pack.
- ★ Do not install or operate the battery pack in potentially explosive atmosphere or areas of high humidity.
- ★ If moisture has penetrated the battery pack (e.g. due to a damaged enclosure), do not install or operate the battery pack.
- ★ In case of contact with electrolyte, rinse the affected areas immediately with water and consult a doctor without delay.

**CAUTION****Risk of burns due to hot heatsink and housing**

The heatsink and housing can get hot during operation.

- ★ During operation, do not touch any parts other than the cover of the inverter.

**NOTICE****Damage to the inverter due to electrostatic discharge**

- ★ Touching electronic components can cause damage to or destroy the inverter through electrostatic discharge.
- ★ Ground yourself before touching any component.









**NOTICE****Damage due to cleaning agents**

The use of cleaning agents may cause damage to the product and its components.















- ★ Clean the product and all its components only with a cloth moistened with clear water.

## 2.4 Symbols on the label

### Symbols on the Type Label of the Inverter

Symbol	Explanation
	Beware of a danger zone This symbol indicates that the product must be additionally grounded if additional grounding or equipotential bonding is required at the installation site.
	Beware of electrical voltage The product operates at high voltages.
	Beware of hot surface The product can get hot during operation.
	Danger to life due to high voltages in the inverter; observe a waiting time of 5 minutes High voltages that can cause lethal electric shocks are present in the live components of the inverter. Prior to performing any work on the inverter, disconnect it from all voltage sources as described in this document.
	WEEE designation Do not dispose of the product together with the household waste but in accordance with the disposal regulations for electronic waste applicable at the installation site.
	Observe the documentation Together with the red LED, this symbol indicates an error.
	Certified safety The product is TUV-tested and complies with the requirements of the EU Equipment and Product Safety Act.
	CE marking The product complies with the requirements of the applicable EU directives.
	RCM (Regulatory Compliance Mark) The product complies with the requirements of the applicable Australian standards.

### Symbols on the type label and warning label of the battery pack:

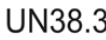
Symbol	Explanation
	Beware of a danger zone This symbol indicates that the product must be additionally grounded if additional grounding or equipotential bonding is required at the installation site.
	Beware of electrical voltage The product operates at high voltages
	Risk of chemical burns
	Risk of explosion
	WEEE designation Do not dispose of the product together with the household waste but in accordance with the disposal regulations for electronic waste applicable at the installation site.
	Observe the documentation Together with the red LED, this symbol indicates an error.
	Risk of electrolyte leakage
	CE marking The product complies with the requirements of the applicable EU directives.
	Refer to the instruction for operation
	Use eye protection
	Fire, naked light and smoking prohibited
	No nearing
	Do not dispose of the battery pack together with the household waste but in accordance with the locally applicable disposal regulations for batteries.
	Recycling code
	Marking for transport of dangerous goods The product passes the certifications of the UN38.3

03 Product Introduction and Application Scenarios

3.1 Inverter Description

Inverter appearance and dimensions

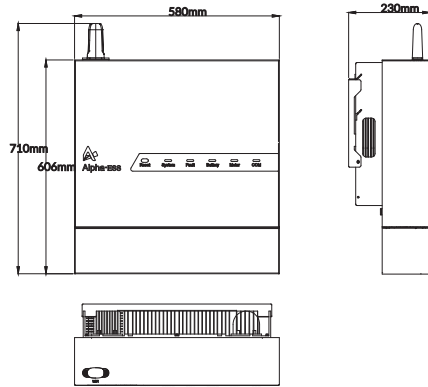

Inverter LED Signals

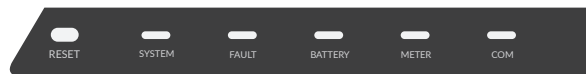

Five LED indicators and one reset button are provided on the display panel. These LED indicators provide information about the operational status of the system. The external communication devices will be restarted with the inverter if you long press the reset button for 5s.

LED Indicator	Status	Explanation
SYSTEM		The system works normally.
		The system is not operating.
FAULT		A fault of the system has occurred.
		No fault

LED Indicator	Status	Explanation
BATTERY		The battery pack works normally.
		Battery communication exists but is not working normally
		Battery communication lost
METER		Meter communication works normally.
		Meter communication lost
		Grid Meter communication lost in AC or Hy-brid mode, flash once every 500ms
		PV Meter communication lost in AC or Hybrid mode, flash once every 1s
COM		Normal communication with the server
		Disconnect to the server
		Normal communication with the APP, flash once every 4s
		Connected to the server but not logged in ,flash once every 2s
		Connected to the router, flash once every 1s
		Connected to the WiFi module, flash once every 500ms

### 3.2 Battery Pack Description

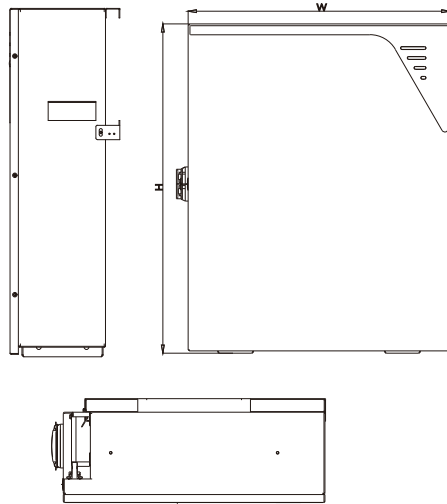

Figure 1 Battery pack appearance and dimensions

Item	SMILE-BAT-8.2PH (OUTDOOR)	SMILE-BAT-8.2PH (INDOOR)
Dimension (W*H*D)	580*820*213 mm	580*730*230 mm

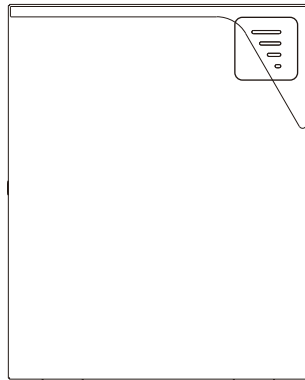

Figure 2 Battery pack LED signals

Four LED indicators are provided on the display panel. Different colors represent different states, green for SOC state, yellow for protection state, red for error state.

The LED indicators provide information about the SOC operational status of the battery pack.

LED Indicator	SOC	Description
Standby: Green LEDs flash every second		$SOC \leq 5\%$ The first line of the LED indicator flashes every 10s.
		$5\% < SOC \leq 30\%$ The first line of the LED indicator is always on. When the battery is being charged, the first line of the LED indicator will flash every 3s.
		$30\% < SOC \leq 55\%$ The first and second line of the LED indicator are always on. When the battery is being charged, the second line of the LED indicator will flash every 3s.
		$55\% < SOC \leq 80\%$ The first, second and third line of the LED indicator are always on. When the battery is being charged, the third line of the LED indicator will flash every 3s.
		$80\% \leq SOC \leq 100\%$ All the LED indicators are always on. When the battery is being charged, the fourth line of the LED indicator will flash every 3s.

### 3.3 Application Scenarios

AlphaESS SMILE-T10-HV system (include SMILE-T10-HV-INV and SMILE-BAT-8.2PH) can be applied in DC-coupled systems (mostly new installation), AC-coupled systems (mostly retrofit) and Hybrid-coupled systems (mostly retrofit, and PV capacity -increase), as the following scheme show:

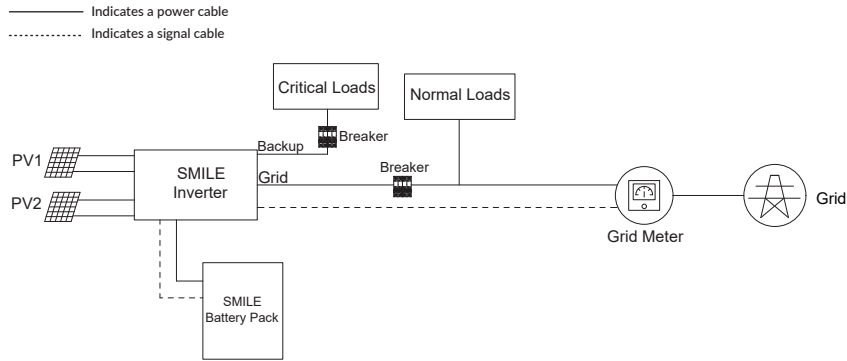

Figure 1 DC-coupled Storage System - Scheme

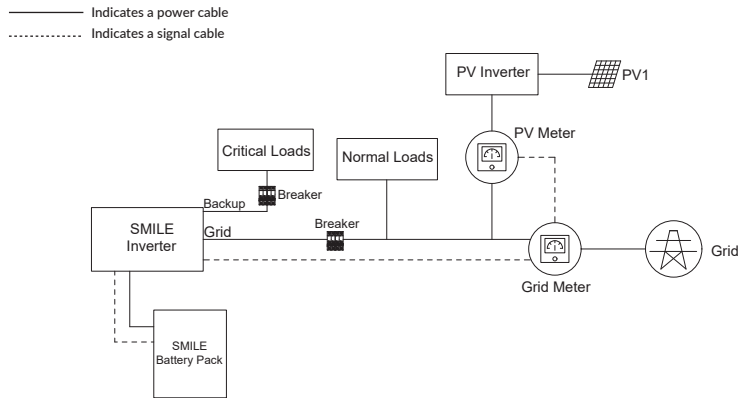

Figure 2 AC-coupled Storage System - Scheme

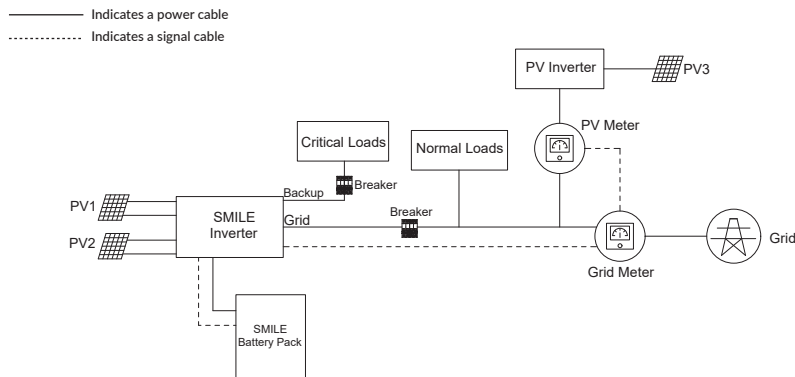

Figure 3 Hybrid-coupled Storage System - Scheme

04 Storage

4.1 Inverter Storage

The following requirements should be met if the inverter is not put into use directly:

1. Do not unpack the inverter.
2. Keep the storage temperature at -40~70°C and the humidity at 5%~95% RH.
3. The inverter should be stored in a clean and dry place and be protected from dust and water vapor corrosion.
4. Up to six inverters can be stacked. To avoid personal injury or device damage, please stack inverters with caution to prevent them from falling over.
5. During the storage period, check the inverter periodically. (It is recommended that the check is performed every three months.) Replace the packing materials that are damaged by insects or rodents in a timely manner.
6. If the inverters have been stored for more than two years, it must be checked and tested by professionals before being put into use.

4.2 Battery Storage

The following requirements should be met if the battery pack is not put into use directly:

1. Place batteries according to the signs on the packing case during storage. Do not put batteries upside down or sidelong.
2. Stack battery packing cases by complying with the stacking requirements on the external package.
3. Store the battery pack out of reach of children and animals.
4. Store the battery pack where it should be minimal dust and dirt in the area.
5. Handle batteries with caution to avoid damage.
6. The storage environment requirements are as follows:
  - Ambient temperature: -10~55°C; recommended storage temperature: 15~30°C
  - Relative humidity: 15%~ 85%
  - Place batteries in a dry and clean place with proper ventilation.
  - Place batteries in a place that is away from corrosive organic solvents and gases.
  - Keep batteries away from direct sunlight.
  - Keep batteries at least 2 meters away from heat sources.
7. The batteries in storage must be disconnected from external devices. The indicators (if any) on the batteries should be off.
8. Batteries should be delivered based on the "first in, first out" rule.
9. The warehouse keeper should collect battery storage information every month and periodically report the battery inventory information to the planning department. The batteries that have been stored for nearly 6 months should be recharged timely.
10. If a lithium battery is stored for a long time, capacity loss may occur. If a lithium battery is stored for 12 months in the recommended storage temperature, the irreversible capacity loss rate is 3%~10%. It is recommended that batteries not be stored for a long period. If the batteries need to be stored for more than 6 months, it is recommended to recharge the batteries to 65~75% of the SOC. For example, they can be recharged every 6 months at least, and must be recharged to at least 50% of the SOC.

05

Unpacking











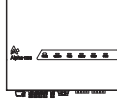

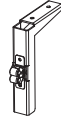
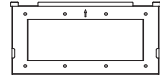
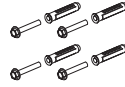
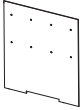
5.1 Checking the Outer Packing

Before unpacking the battery pack and inverter, check the outer packing for damage, such as holes and cracks. If any damage is found, do not unpack the product and contact your dealer as soon as possible.

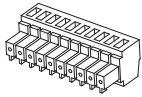
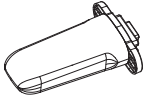
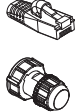

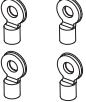

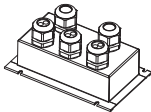

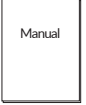
5.2 Scope of Delivery

Check the scope of delivery for completeness and any externally visible damage. Contact your distributor if the scope of delivery is incomplete or damaged.

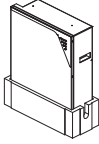
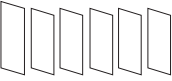
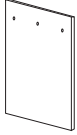
SMILE-T10-HV-INV (INDOOR/OUTDOOR) Hybrid Inverter

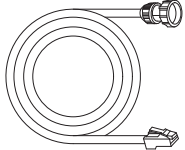
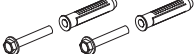
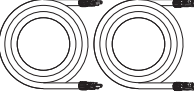
				
Inverter (X1)	Cable Cover (X1)	Cable Cover Holder (X2)	Inverter Wall Bracket (X1)	Wall Anchor ST6*55 (X4)
				
Inverter Positioning Paper Plate (X1)	PV Connector (X4)	PV Connector (X4)	Cord end Terminal (X11)	10 Pin Terminal Block (X1)
	 Indoor Use  Outdoor Use			
WiFi Module (X1)	Terminal Resistor (X1)	Ring Terminal Lug (X4)	Screw M5*10 (X3) Screw M5*12 (X2) Screw M4*10 (X8)	T20 Screwdriver (X1)
				
AC&COM Connection Cover (X1)	PC Gasket (X1)	Installation Manual (X1)		

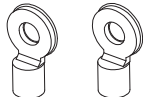
SMILE-BAT-8.2PH

			
Battery Pack (X1)	Floor Gasket (X6)	Battery Positioning Paper Plate (X1)	Battery Wall Bracket (X1)
			
Cardboard limit board (X1)	Battery COM Cable (X1)	Wall Anchor ST6*55 (X2)	Power Cable + (X 1) Power Cable - (X 1)
			
Screw M5*12 (X 2)	Screw M6*6 (X2)	Ring Terminal Lug (X2)	Battery User Manual (X1)

6.1 Requirements for Mounting

**WARNING**

- Danger to life due to fire or explosion  
 Despite careful construction, electrical devices can cause fires.
- ★ Do not mount the product in areas containing highly flammable materials or ash.
  - ★ Do not mount the product in potentially explosive atmospheres.

Basic Requirements

- ★ SMILE-T10-HV-INV (OUTDOOR) and SMILE-BAT-8.2PH (OUTDOOR) are suitable for indoor and outdoor use.  
 SMILE-T10-HV-INV (INDOOR) and SMILE-BAT-8.2PH (INDOOR) are suitable for only indoor use.
- ★ Do not install the inverter in a place where a person can easily touch it because its housing and heat sinks are extremely hot during operation.
- ★ Do not mount the product in areas with flammable or explosive materials.  
 o not mount the product at a place within children's reach.
- ★ Do not mount the product outdoors in salt areas because it will be corroded there and may cause fire. A salt area refers to the region within 500 meters from the coast or prone to sea breeze. The regions prone to sea breeze vary depending on weather conditions (such as typhoons and monsoons) or terrains (such as dams and hills).

Mounting Environment Requirements

- ★ The product must be mounted in a well-ventilated environment to ensure good heat dissipation.
- ★ When mounted under direct sunlight, the power of the product may be derated due to additional temperature rise.
- ★ Mount the product in a sheltered place or mount an awning over the product.
- ★ The optimal temperature range for the battery pack to operate is from 15 to 30°C.
- ★ Do not expose or place near water sources like downspouts or sprinklers.
- ★ If the battery pack is mounted in the garage then ensure that it is above the height of the vehicle bumper and/or door.

Mounting Structure Requirements

- ★ The mounting structure where the product is mounted must be fireproof.
- ★ Do not mount the product on flammable building materials.
- ★ Ensure that the mounting surface is solid enough to bear the weight load.
- ★ In residential areas, do not mount the inverter on drywall or walls made of similar materials which have a weak sound insulation performance because the noise generated by the inverter is noticeable.

Mounting Angle and Stack Requirement

The battery pack should be floor-mounted and the inverter should be wall-mounted. The installation angle requirement is as follow:  
 Do not mount the battery pack and inverter at forward tilted, back tilted, side tilted, horizontal, or upside down positions.

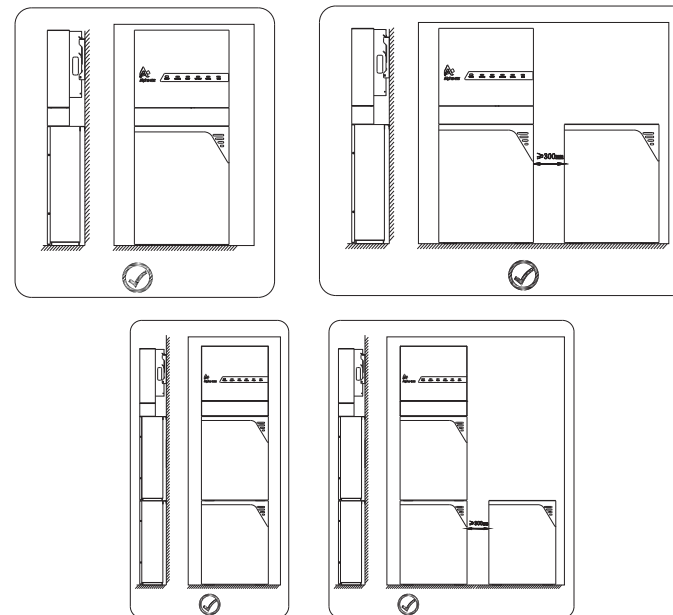





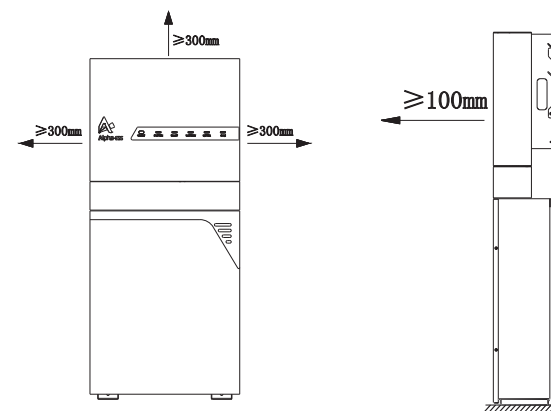





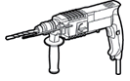



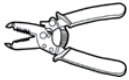



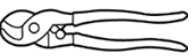



Mounting Space Requirements

- ★ Reserve sufficient clearance around the battery pack and inverter to ensure sufficient space for installation, maintenance and heat dissipation.





## 6.2 Preparing Tools and Instruments

Category	Tools and Instruments		
Installation	 Hammer drill (with a $\Phi 10$ mm drill bit)	 Torque socket wrench SW10	 Multimeter (DC voltage measurement range $\geq 1000$ V DC)
	 Diagonal pliers	 Wire stripper	 Torque screwdriver (slotted head, torque range: 0-5 N m)
	 Rubber mallet	 Utility knife	 Cable cutter
	 Crimping tool (model: PV-CZM-22100)	 Cord end terminal crimper	 Disassembly and Assembly Tool (model: PV-MS-HZ open-end wrench)
	 Vacuum cleaner	 Heat shrink tubing	 Heat gun
	 Marker	 Measuring tape	 Bubble or digital level
Personal protective equipment	 Safety gloves	 Safety goggles	 Anti-dust respirator
	 Safety shoes	N/A	N/A

## 6.3 Mounting the Battery Pack and Inverter

### 6.3.1 Mounting the battery pack

1. Lift the battery pack by using the handles at the two sides, take it out from the package carton. Do not put the battery pack upside down on the ground.

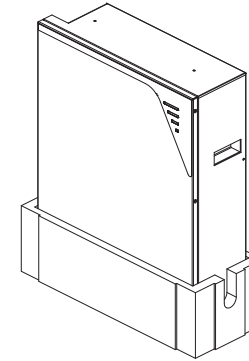

2. Place the battery positioning paper plate against the wall and the bottom against the floor, and mark the positions of the two drill holes.

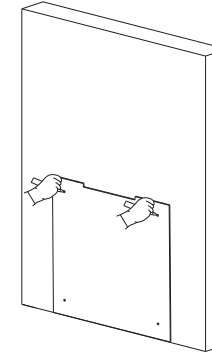

3. Drill 2 holes on the wall with a diameter of 10mm and a depth of about 70mm.

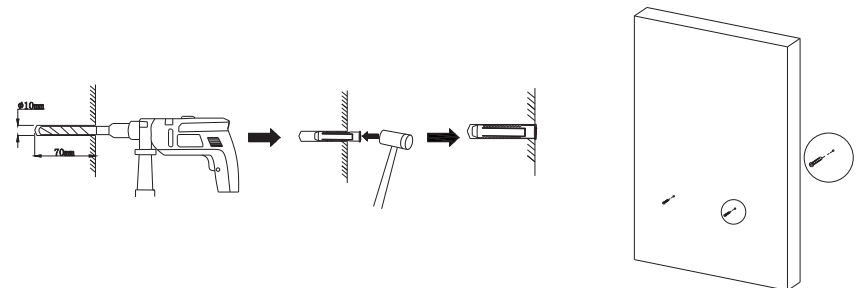

- After cleaning the dust and other objects from the two holes, place 2 wall anchors into the holes, then attach the battery wall bracket to the wall by using the SW10 hexagon sleeve.

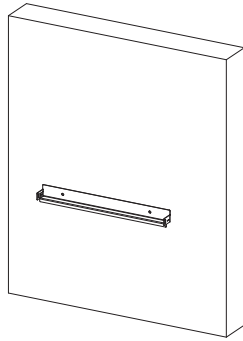

- Install the cardboard limit board on the battery pack with screw M5\*12 (X 2) (tool: T20 screwdriver, torque: 2.5Nm).

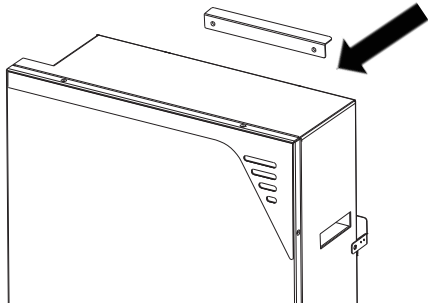

- Place the battery against the wall, align the holes at the battery side to the screw holes of the wall bracket.
- Tighten the wall bracket and the battery pack with screw M5\*12 (X 2) (tool: T20 screwdriver, torque: 2.5Nm)  
If the floor of installation site is uneven, please use floor gaskets to level at the bottom of the battery pack.

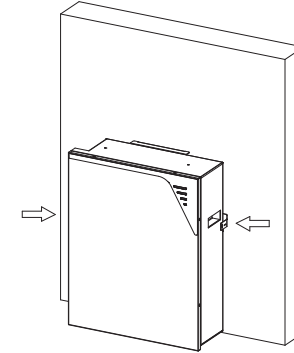

**! WARNING**

Risk of injury when lifting the battery pack, or if it is dropped  
The Battery Pack is very heavy weighs  $\geq 72$  kg. There is risk of injury if the battery pack is lifted incorrectly or dropped while being transported or when attaching it to or removing it from the wall bracket.

- ★ Transport the battery pack always as described below.
- ★ It is forbidden to stack 3 batteries from top to bottom.

- Mounting more batteries  
You can install extra batteries up to 6 batteries in a system.  
Please install extra batteries by side, also batteries can be stacked up to two batteries per column. Expansion wiring please refer to Chapter 7.9 .
- If you will install extra batteries by side, please repeat steps 1-6 and keep the distance between two batteries greater than 300mm. The space between the left and the right battery is a recommended distance. Keep the distance as short as you can if there is no influence to the operation.

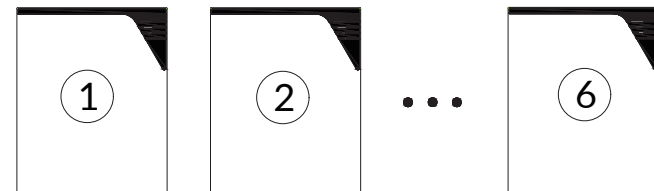

2) For battery stack, lock the screw M6\*6 on top of the first battery pack.

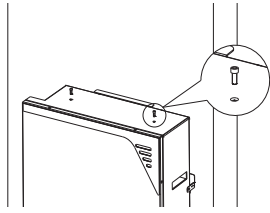

Place the battery positioning paper plate against the wall and the bottom with notch against the first battery pack. Repeat steps 1-7.

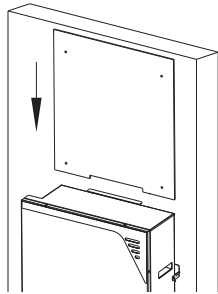

The bottom limit holes of the second battery will match the top screws of the first battery.

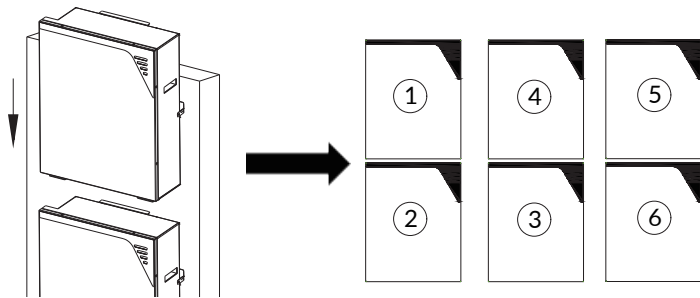

### 6.3.2 Mounting the inverter

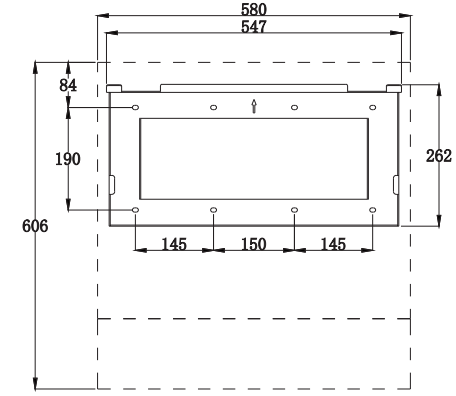

Dimensions in mm

The steps to mount the inverter are listed below:

1. Fit the bottom of the inverter's positioning paper plate into the top of the battery against wall, mark the positions of the drill holes on the paper plate.

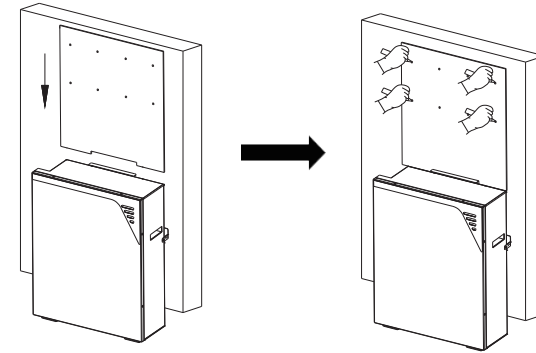

2. Cover the top of the battery with plastic bag and drill 4 holes on the wall with drill 10, insert 4 screw anchors into the drill holes.

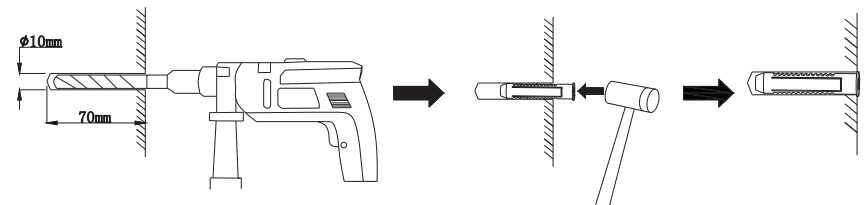

- Attach the wall bracket to the wall using the screws with the tool of SW10 hexagon sleeve.

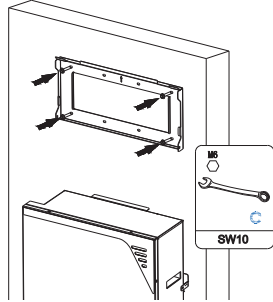

- Hold the inverter by using the handles at two sides, attach the inverter onto the wall bracket tilted slightly downwards. For easy wiring, please hang the **second slot** on the back of the inverter onto the wall bracket.

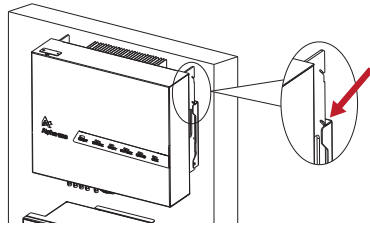

- Attach two holders to the sides of the bottom of the inverter and tighten them.

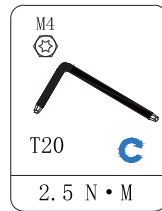
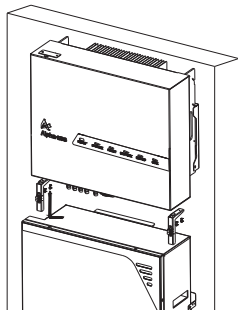

- Make electrical connection (please refer to Section 7 Electrical Connection).

### 6.3.3 Mounting the WiFi module

- Remove the WiFi cover from the top of the inverter with Torx 20 screwdriver.

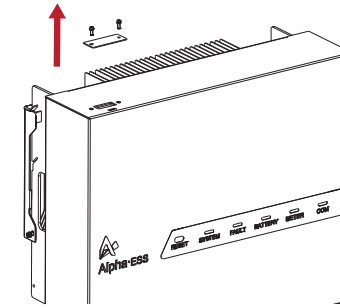

- Tighten the WiFi module on top of the inverter.

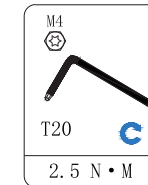
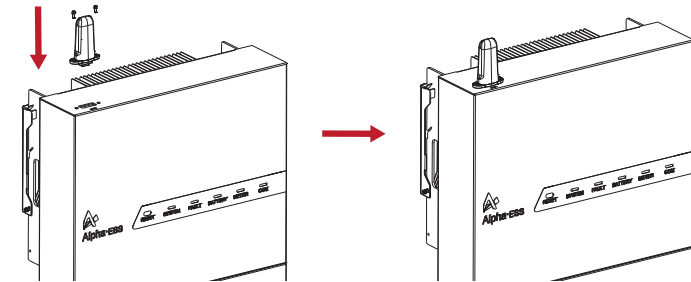

**07 Electrical Connection**

**Precautions**

**! DANGER**

Before connecting cables, ensure that all switch and breaker of the inverter and the battery pack and all the switches connected to inverter and the battery pack are set to OFF. Otherwise, the high voltage of the product may result in electric shocks.

**! WARNING**

- ★ The device damage caused by incorrect cable connections is not covered under any warranty.
- ★ Only certified electricians are allowed to connect cables.
- ★ Operation personnel must wear proper PPE when connecting cables.

**NOTICE**

The cable colors shown in the electrical connection diagrams provided in this chapter are for reference only. Select cables in accordance with local cable specifications (green-and-yellow cables are only used for PE).

**7.1 Overview of the Connection Area**

**7.1.1 Overview of the Inverter Connection Area**

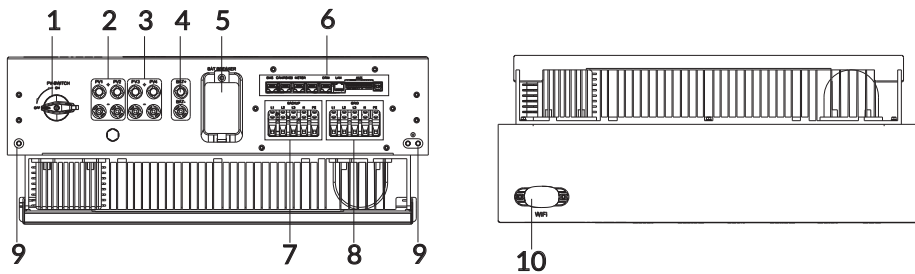

Position	Designation
1	PV switch
2	2 positive and 2 negative PV connectors, PV input A
3	2 positive and 2 negative PV connectors, PV input B
4	1 positive and 1 negative BAT power connectors
5	Battery breaker*
6	Communication port ( BMS, CAN/RS485, Meter, DRM**, LAN, AUX )
7	Backup connection port
8	Grid connection port
9	Connection point for an additional grounding
10	Connection port for the WiFi module

\*All breakers are switched off in transportation.

\*\*The DRM (Demand Response Enabling Device) is only for regions with AS/NZW 4777.2 safety regulations.

The following table is about DRM interface definition.

Mode	Requirement
DRM0	Operate the disconnection device
DRM1	Do not consume power
DRM2	Do not consume at more than 50% of rate power
DRM3	Do not consume at more than 75% of rate power AND Source reactive power if capable
DRM4	Increase power consumption (subject to constraints from other active DRMs)
DRM5	Do not generate power
DRM6	Do not generate at more than 50% of rate power
DRM7	Do not generate at more than 75% of rate power AND Sink reactive power if capable
DRM8	Increase power generation (subject to constraints from other active DRMs )

### 7.1.2 Overview of the Battery Pack Connection Area

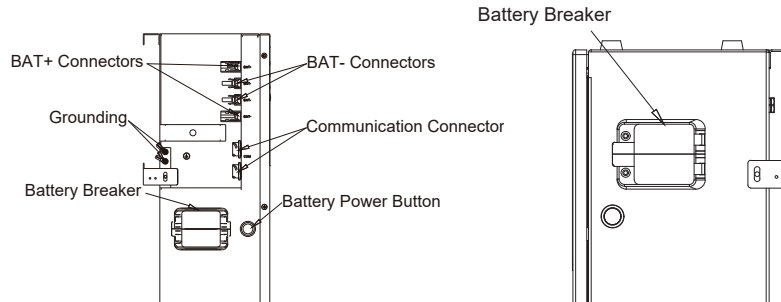

The battery breaker is switched off when shipped.

### 7.2 Preparing Cables

No.	Cable	Type	Conductor Cross Section Area Range	Outer Diameter	Source
1	Battery Power cable	Standard PV cable in the industry (recommended model: PV1-F)	6 ~ 10 mm <sup>2</sup>	8.1 ~ 10.2 mm	Delivered with the battery pack
2	Battery communication cable	Standard Network cable in the industry (recommended type: Cat5e, UTP, UV-resistant for outdoor use)	0.12 ~ 0.2 mm <sup>2</sup> (AWG26~AWG24)	4~6 mm	Delivered with the battery pack
3	PV power cable	Standard PV cable in the industry (recommended type: PV1-F)	4 ~ 6 mm <sup>2</sup>	5.5~9 mm	Purchased by the installer
4 <sup>※1</sup>	Signal cable	Standard Network cable in the industry (recommended type: Cat5e, FTP, UV-resistant for outdoor use)	0.12 ~ 0.2 mm <sup>2</sup> (AWG26~AWG24)	4~6 mm	Purchased by the installer
5 <sup>※2</sup>	Signal cable	multiple-core outdoor shielded twisted pair cable	0.1 ~ 1.3 mm <sup>2</sup>	4~6 mm	Purchased by the installer
6	AC power cable	Five-core (L1, L2, L3, N, and PE) outdoor copper cable	4 ~ 6 mm <sup>2</sup>	12~16 mm	Purchased by the installer
7	PE cable	Single-core outdoor copper cable with an M5 OT terminal	4 ~ 10 mm <sup>2</sup>	N/A	Purchased by the installer

※1 For CAN/RS485, LAN, Meter, DRM communication connection with inverter.

※2 For AUX communication connection with inverter

### 7.3 Connecting Additional Grounding

An external grounding connection is provided at the bottom sides of the inverter. Prepare M5 OT terminals, strip the grounding cable insulation, insert the stripped part of the grounding cable into the ring terminal lug and crimp using a crimping tool. Connect the OT terminal with grounding cable using the torque is 3 Nm with tool of T20 screwdriver.

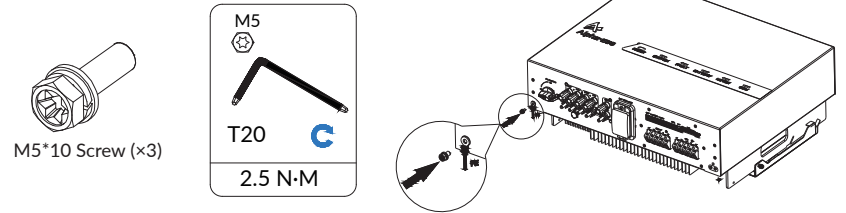

An external grounding connection is provided at the left side of battery pack. Prepare and connect grounding connection as above. The Battery Pack and the inverter need to be grounded.

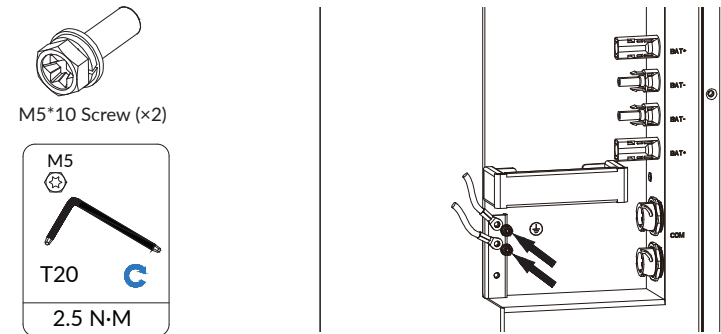

### 7.4 AC Connection

#### 7.4.1 Conditions for the AC Connection

An AC breaker must be installed on the AC side of the inverter to ensure that the inverters can be safely disconnected from the power grid and the load.

**! DANGER**

**Danger to life due to fire!**

You must protect each inverter with an individual AC circuit breaker in order to ensure that the inverter can be disconnected safely.

Do not connect loads between the inverter and the grid breaker.  
 No consumer load should be applied between the AC circuit breaker and the inverter. Use dedicated circuit breakers with load switch functionality for load switching. The selection of the AC circuit breaker rating depends on the wiring design (wire cross-section area), cable type, wiring method, ambient temperature, inverter current rating, etc. Derating of the AC circuit breaker rating may be necessary due to self-heating or if exposed to heat. The maximum AC current of the inverters can be found in the following table. We recommend the following AC circuit breaker for AC connection.

Description	Max Current	Recommend AC Circuit Breaker Rating
Grid side	21.7A	32A
Backup side	14.5A	20A

### 7.4.2 Grid and Backup Connection

There are two AC terminal blocks for grid and backup connection which have the same assembly steps. We recommend the following cable requirements for AC connection.

Description	Value
Cable diameter	12~16 mm
Copper conductor cross section area range	4~6 mm <sup>2</sup>
Stripping length of the insulated conductors	10~12 mm

1. Take out the cord end terminals and AC&COM connection cover provided by the inverter.
2. Lead the AC cable through the cable gland of the AC&COM connection cover, don't tighten the pressure cap of the cable gland.

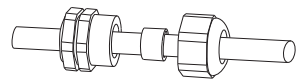
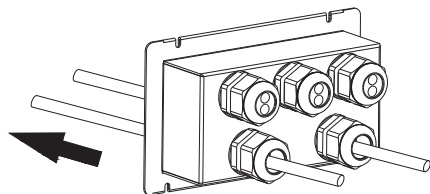

Installation method of AC cable via M25 cable gland

3. Dismantle the AC cable by 80 mm, and strip the insulation of L1, L2, L3, N and the grounding conductor by 10mm.

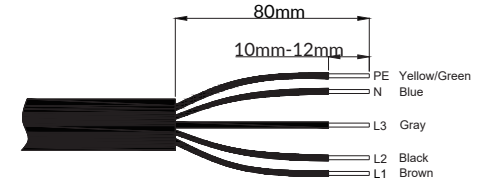

4. Insert the stripped part of the conductors into the cord end terminals and crimp them using a crimping tool.

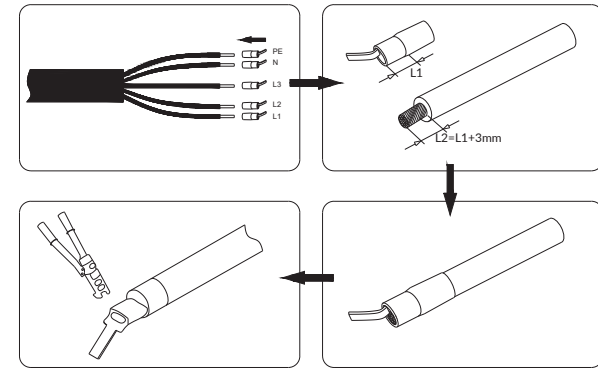

5. Insert the terminals with different color conductor to the hole of the respective polarity and tighten them one by one using the torque of 2 Nm with tool of #2 slotted screwdriver.

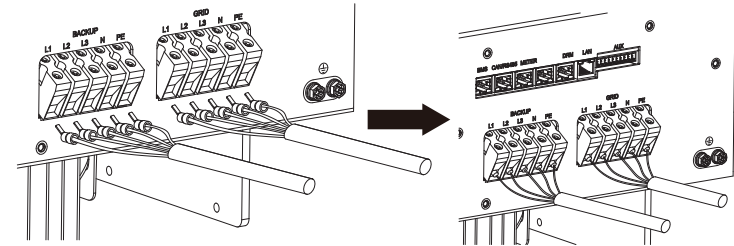

### NOTICE

For Australia and New Zealand installation site, the neutral cable of grid side and backup side must be connected together, otherwise backup output function will not work.

### 7.4.3 Residual Current Protection

The inverter is equipped with an all-pole sensitive residual current monitoring unit (RCMU) with an integrated differential current sensor which fulfills the requirement of DIN VDE0100-712(IEC60364-7-712:2002). Therefore, an external residual current device (RCD) is not required. If an external RCD needs to be installed because of local regulations, a RCD type A or type B can be installed as an additional safety measure. The all-pole sensitive residual current monitoring unit (RCMU) detects alternating and direct differential currents. The integrated differential current sensor detects the current difference between the neutral conductor and the line conductors. If the current difference increases suddenly, the inverter disconnects from the grid. The function of the all-pole sensitive residual current monitoring unit (RCMU) has been tested according to IEC62109-2.

**i** Notice of installing an external residual current device (RCD) for installation of Australia and New Zealand

Where an external residual current device (RCD) is required in a TT or TN-S system, please install a residual current device which trips at a residual current of 30mA.

### 7.4.4 Meter Connection

The system supports the following two different metering schemes in order to record the feed-in energy and consumption from grid:

- ★ DTSU666-3\*230V 5A: Three/single-phase meter (without CT)
- ★ DTSU666-100/40mA: Three/single-phase meter (with 3 or 6 CT)

#### Meter wiring introduction

#### NOTICE

- ★ If the extra PV inverter are not used, the system is suitable for DC mode.
- ★ If you use the extra PV inverter, the system is suitable for AC or Hybrid mode.

### 1.DTSU666-3\*230V 5A: Three-phase meter (without CT) connection

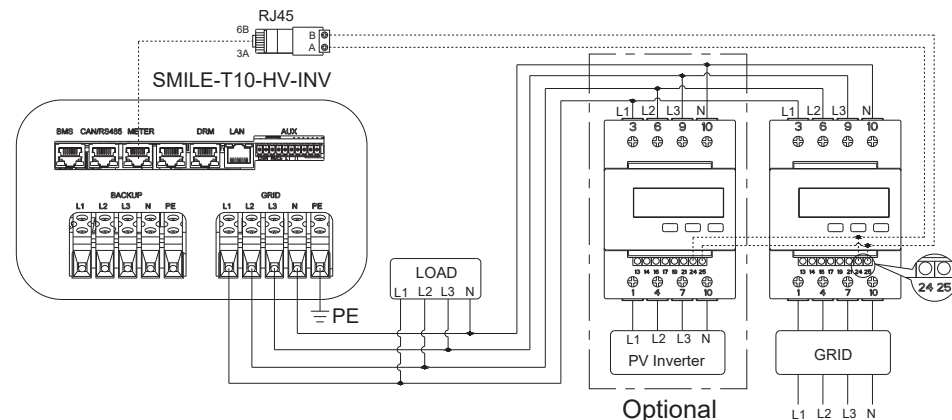

### 2.DTSU666-100/40mA: Three-phase meter (with 3 or 6 CTs) connection

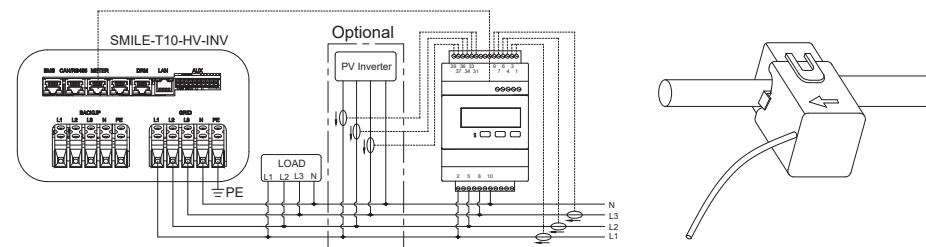

Grid CT	PV CT
1-----IC (White)	31-----IC (White)
3-----IC (Blue)	33-----IC (Blue)
4-----IB (White)	34-----IB (White)
6-----IB (Blue)	36-----IB (Blue)
7-----IA (White)	37-----IA (White)
9-----IA (Blue)	39-----IA (Blue)

**NOTE:** If you have extra PV inverter in the whole system, with 6 CTs, you don't need the second CT meter. 3 CTs are used for the grid side and others for PV inverter side.



### Meter Address Setting

Model	Grid Meter Address	PV Meter Address
DTSU666-3*230 V 5 A (without CT)	1	2
DTSU666-100/40 mA (with CT)	1	N/A

#### 1.DTSU666-3\*230V 5A: Three-phase meter (without CT)

When the meter is used as Grid meter, please follow the steps below to complete the address setting by pressing the corresponding button and the number of times.

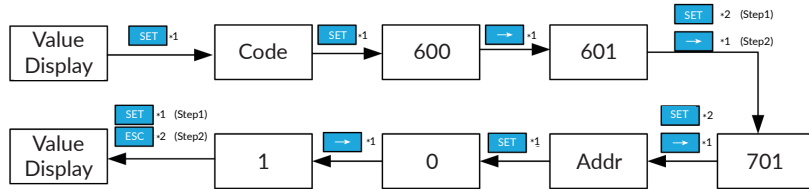

When the meter is used as PV meter, please follow the steps below to complete the address setting by pressing the corresponding button and the number of times.

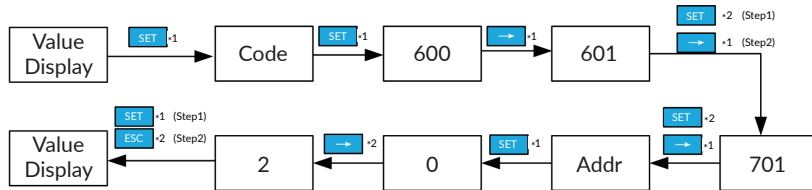

#### 2.DTSU666-100/40mA: Three-phase meter (with CT)

When the meter is used as Grid meter, please follow the steps below to complete the address setting by pressing the corresponding button and the number of times.

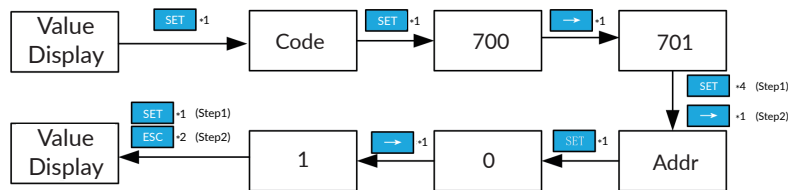

### Meter Setting on AlphaCloud

#### Step 1:

When the system work mode is selected as DC, click the button under the “Grid Meter” to turn the “Meter” green.

When the system work mode is selected as AC or Hybrid, click the buttons under the “Grid Meter” and “PV side meter” to turn the “Meter” green.

#### Step 2:

Click "Save" and wait a few minutes to refresh the page. When the “Meter Model” displays DTSU666 model, the setting is successful.

#### NOTE:

It is forbidden to tick CT to modify the CT ratio.

Meter Information

Grid Meter

Meter  CT      Meter CT Ratio       Meter Model

CT

---

PV side meter

Meter  CT      Meter CT Ratio       Meter Model

CT

### Meter Setting on AlphaAPP

#### Step 1:

When the system work mode is selected as DC, only tick "Meter" on the right of the “Grid Meter”.

When the system work mode is selected as AC or Hybrid, both tick "Meter" on the right of the “Grid Meter” and “PV side meter”.

#### Step 2:

Click "Submit" and enter the “System information” page to check the meter model. The setting is successful if meter model is DTSU666-100/40mA.

#### NOTE:

It is forbidden to tick CT to modify the CT ratio.



### 7.4.5 Backup Box PLUS Connection

**NOTICE**

- ★ The residual current device (RCD) should be connected to the load side.
- ★ For Australia safety regulation, the neutral cable of On-Grid side and Back-Up side must be connected together; otherwise Back-Up function will not work.

Three/single-phase meter (Contain off-grid switching and load management)

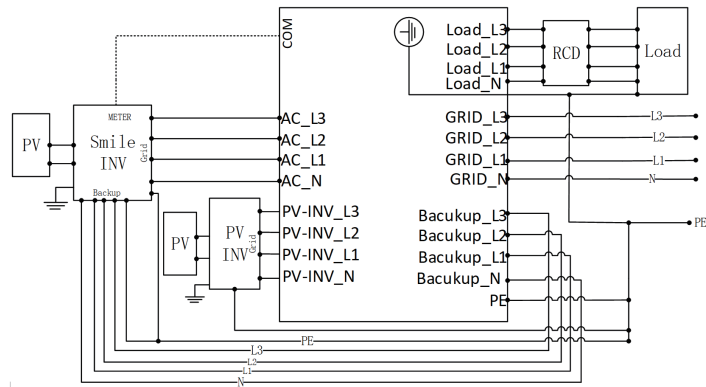

### 7.5 Communication Connection

Communication connection port as follows:

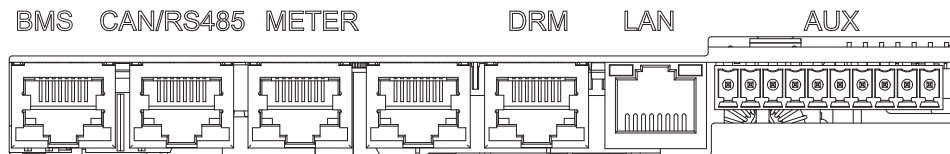

Please follow the below steps for communication connection

1. Lead the communication cables through the cable glands of the AC&COM connection cover, don't tighten the pressure caps of the cable glands. Insert the RJ45 plugs to the relative RJ45 sockets.

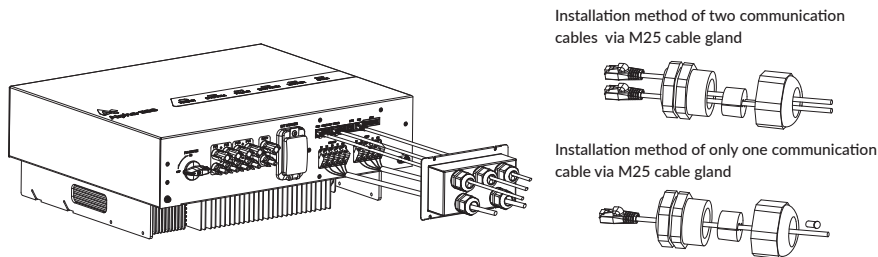

- 1) Connect the BMS port on the inverter and COM port on the battery with communication cable.
- 2) For meter wiring, please read electricity meter wiring instructions of the meter.
- 3) If DRM support is specified, the system may only be used in conjunction with a Demand Response Enabling Device (DRED). This ensures that the system implements the commands from the grid operator for active power limitation at all times. The system and the Demand Response Enabling Device (DRED) must be connected in the same network.
- 4) Take out 10 pin terminal block for AUX connection.  
For AUX position definition, please refer to the relative wiring document.

2. Place the AC&COM connection cover against the inverter housing and tighten them.

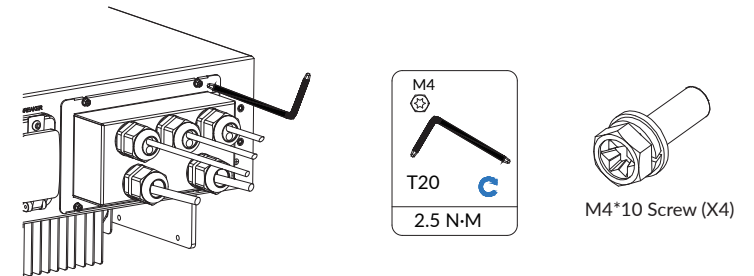

### 7.6 PV Connection

Please ensure the follows before connecting PV strings to the inverter:

- ★ Make sure the open voltage of the PV string will not exceed the max. DC input voltage (1000Vdc). Violating this condition will void the warranty.
- ★ Make sure the polarity of the PV connectors is correct.
- ★ Make sure the PV-switch, breakers of battery, AC-BACKUP and AC-Grid are all in their off-states.
- ★ Make sure the PV resistance to ground is higher than 200KOhms.

The inverter uses the MC4 PV connectors. Please follow the picture below to assemble the MC4 connectors. PV cable cross section requirements: 4~6mm<sup>2</sup>.

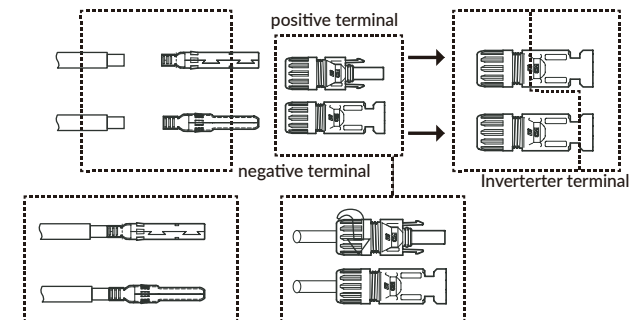

Use appropriate crimping tools for crimping

### 7.7 Battery Power Connection

Please follow the below steps for battery power connection.

1. Disconnect the battery circuit breaker and secure it against reconnection.
2. Take out the battery power cables which are provided by the battery pack.
3. Ensure the correct polarity of power cable of the batteries before connecting to the inverter.
4. Connect the battery power cables to the respective connection ports of the inverter, a "click" sound means fully connection.

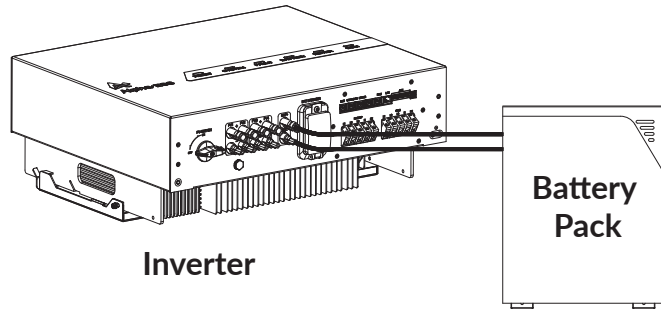

### 7.8 Mounting the Cable Cover

Please follow the below steps to finish the installation of the inverter.

1. Hold the inverter by using the handles at two sides, attach the inverter onto the wall bracket tilted slightly downwards. Please hang the first slot on the back of the inverter onto the wall bracket. Check both sides on the back of the inverter to ensure that it is securely in place.

Please reserve a certain length of all cables, and secure them evenly for easy maintenance.

2. Attach the outer fins of heat sink to both sides of the wall bracket using M5 screws.

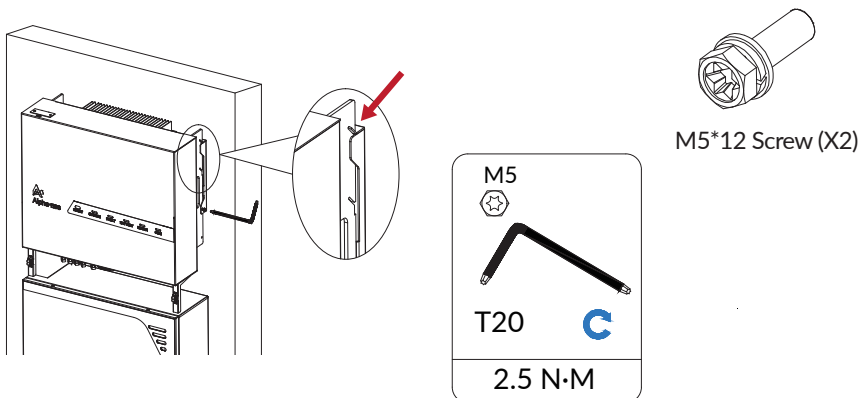

3. Insert the cable cover against the bottom edge of the inverter.

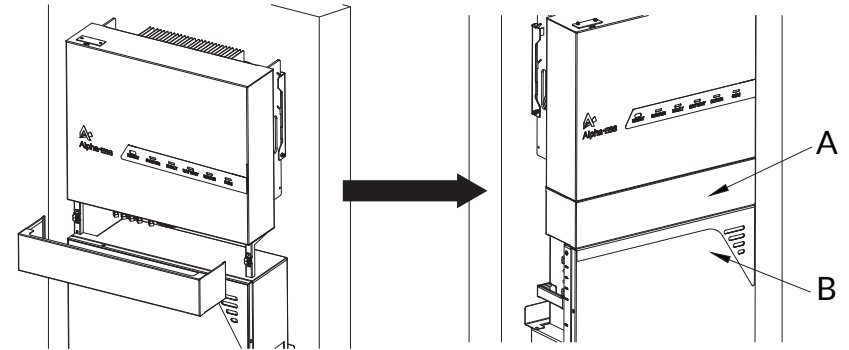

4. If the plane A of the cable cover is not aligned with plane B of the battery, please increase or decrease PC gaskets on the cable cover holders to adjust it.

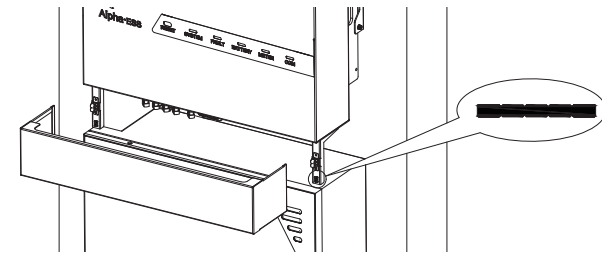

### 7.9 Battery Pack Expansion Connection

You can install extra batteries up to 6 batteries in a system.

Please install extra batteries by side, also batteries can be stacked up to two batteries per column.

- Connect the power cables from battery 2 to battery 1.
- Connect the BMS communication cables from battery 2 to battery 1.

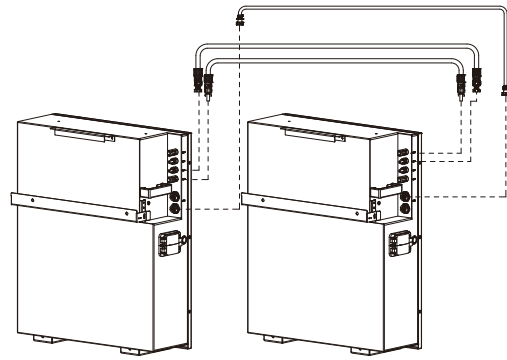

Install extra batteries by side, without stack

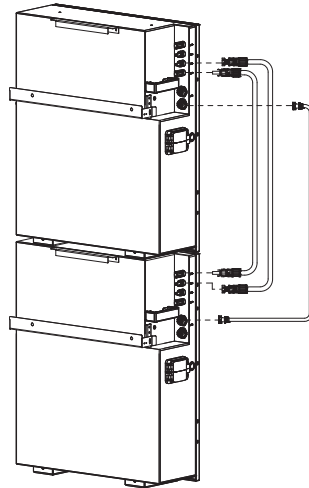

Batteries installed with stack

Take out the terminal resistor provided by the inverter, insert it to the unused communication port of the last battery.

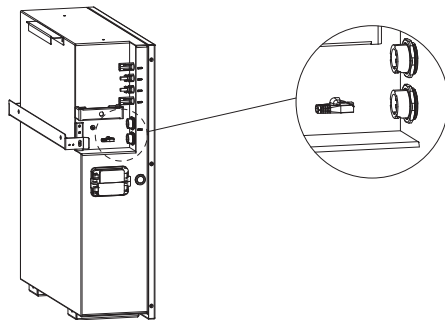

08 WiFi Setting

8.1 Download and Install the Application

1. Android device users can download the app through major Android application markets such as Google Play.
2. IOS device users can search for "AlphaESS" in App Store and download the app.



Figure 6 AlphaESS-APP

## 8.2 Overview of Functions for Installer Account

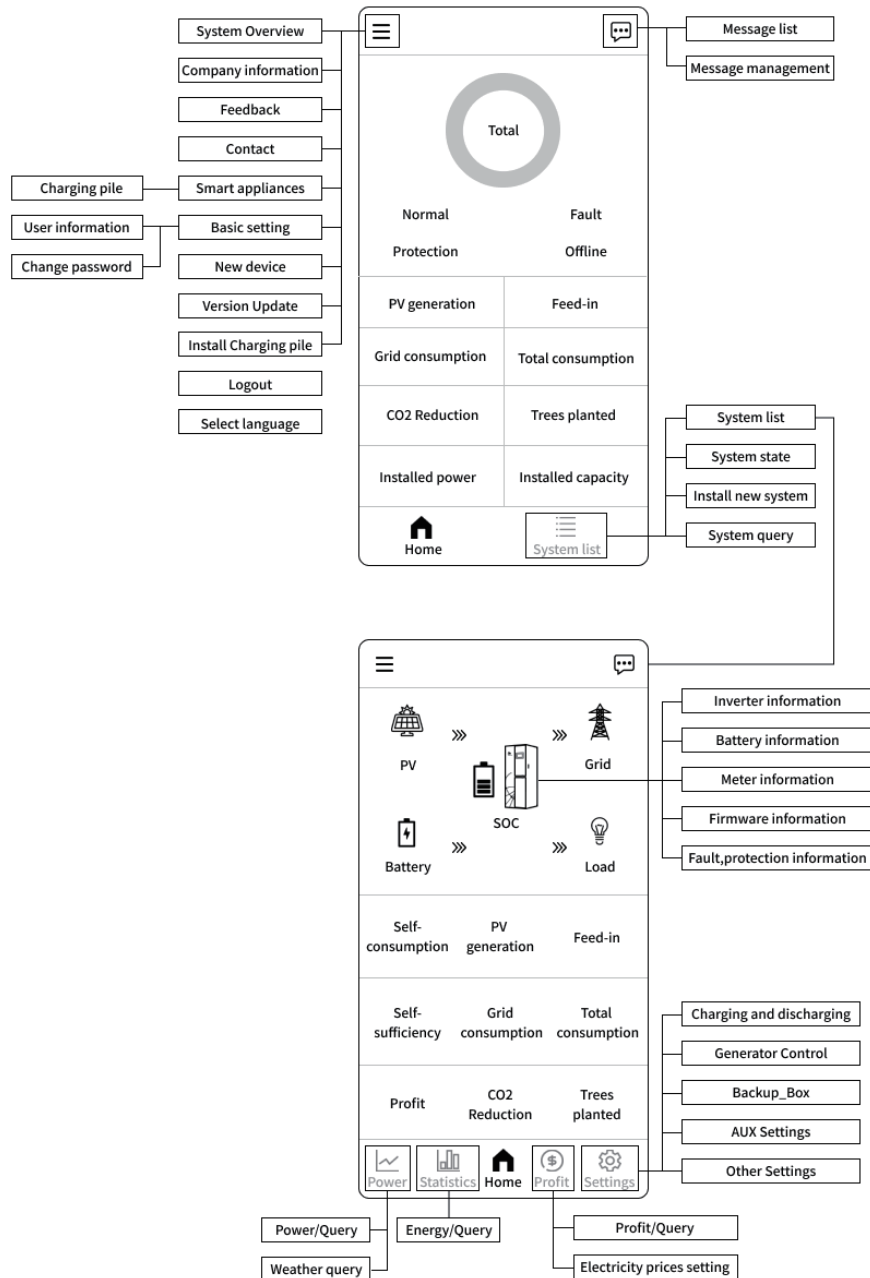

## 8.3 WiFi Module Setting

This section is for users who have a system with a WiFi module. AlphaESS App supports network configuration, setting of the system basic parameter, and the viewing of system operation and configuration information.

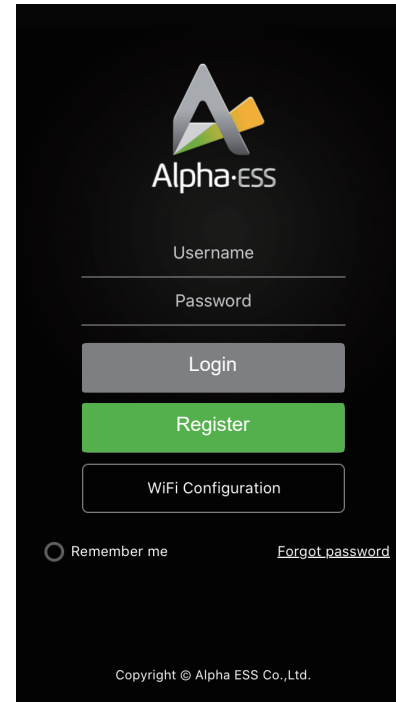

**Step 1:** Open AlphaESS APP, click the “Wi-Fi Configuration” button and enter the WiFi configuration interface.

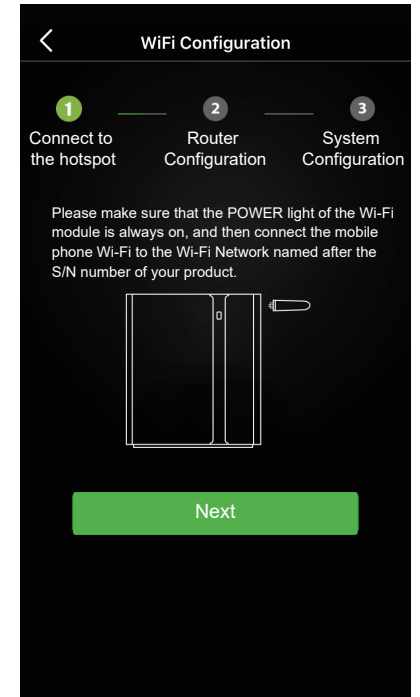

**Step 2:** After that please check whether your mobile phone has connected to the system's hotspot.

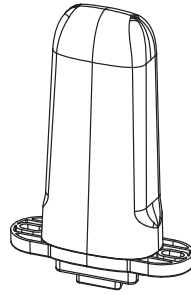
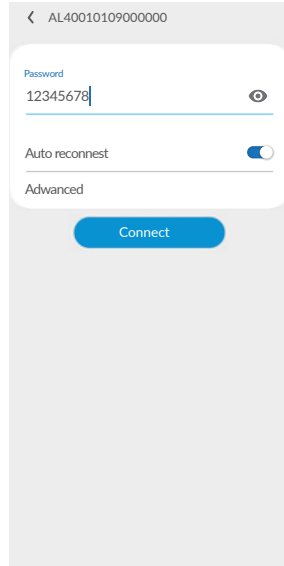
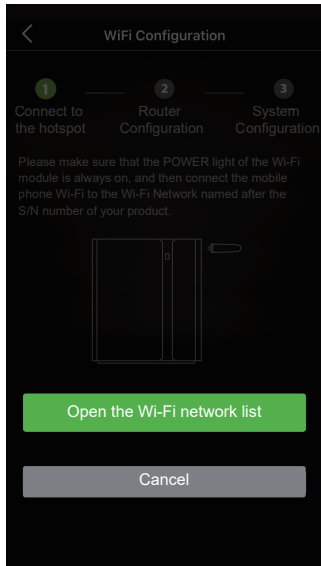

**Step 3:** If your mobile phone hasn't connected to the system's hotspot, please open the Wi-Fi network list. Please find the hotspot named by the product SN in WLAN list then enter the password "12345678" and connect to it. After successfully setting it, please go back to APP and click "Next".

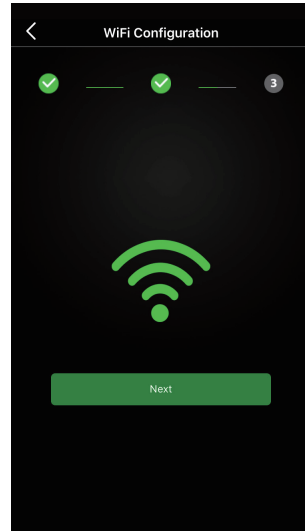
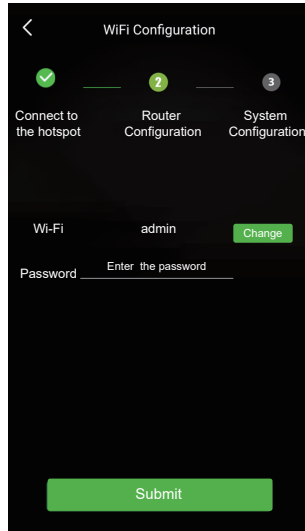
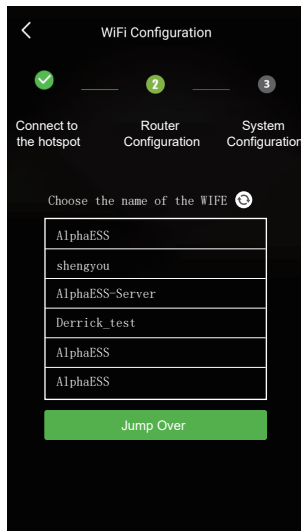

**Step 4:** Select the WiFi of your home you are using, enter the password, complete the WiFi configuration and submit. If there is no network currently, you can click Jump over to skip the WiFi configuration step and directly set the system parameters.

**Note:** The system will not be able to connect to the Internet without WiFi configuration.

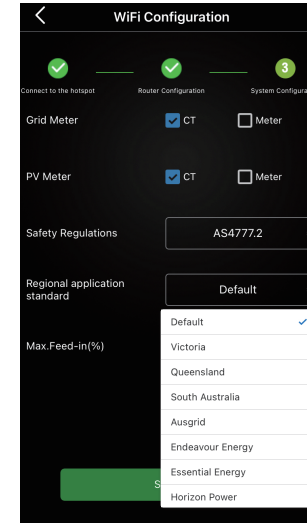

**Step 5:** Set basic parameters, including PV capacity on the grid side, the type of meters, safety regulations and regional application standard. Click "Submit" when the settings are complete.

**Note:** When the safety regulation is set as AS4777.2, the secondary sub-options can be selected according to the region or local grid company (Please refer to Appendix 2).

### 9.1 Checking Before Power-On

Table 9-1 Installation checklist

No.	Check Item	Acceptance Criteria
1	Battery pack and inverter mounting	The battery pack and inverter are mounted correctly, securely, and reliably.
2	WiFi mounting	The WiFi module is mounted correctly, securely, and reliably
3	Cable layout	Cables are routed properly as required by the customer.
4	Cable tie	Cable ties are secured evenly and no burr exists.
5	Grounding	The ground cable is connected correctly, securely, and reliably.
6	Switch and breakers status	All breakers connecting to or on the product are OFF.
7	Cable connections	The AC cable, PV cable, battery cable, and communication cables are connected correctly, securely, and reliably.
8	Unused power terminals	Unused power terminals are blocked by watertight caps.
9	Mounting environment	The mounting space is proper, and the mounting environment is clean and tidy, without foreign object.

### 9.2 Check the Running State

#### Prerequisites

Before switching on the AC breaker between the inverter and the grid, check whether the AC voltage on the power grid side of the AC breaker is within the specified range. Please select the acceptance of installation on site when the light intensity is strong.

#### Procedure

1. Ensure that the all breakers connecting to or on the product are OFF.
2. Check the grid-connected state of the product  
 Short press the power button on the left side of battery pack, then switch on the battery breaker on the right side of battery pack.  
 Switch on the battery breaker which is located at the bottom middle inverter.  
 Switch on the PV switch which is located at the bottom left inverter.  
 Switch on the external AC breaker between the grid and the inverter.  
 Set the operating parameters through the APP.  
 Wait about 3 minutes for the inverter to enter the grid-connected state, and observe

the indicators states on the display panel of the inverter. At this time, the following 4 LEDs ("SYSTEM", "BATTERY", "METER", "COM") on the display panel is always on.

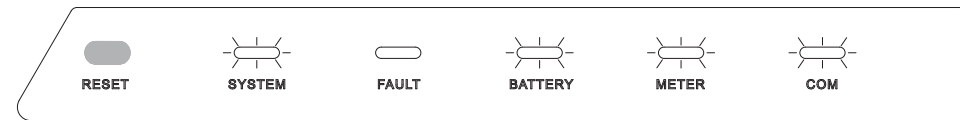

3. Check the UPS state of the product  
 Switch off the external AC breaker between the grid and the inverter. The inverter will enter the UPS state at once, and observe the indicators states on the display panel of the inverter. At this time, the following 3 LEDs ("SYSTEM", "BATTERY", "COM") on the display panel is always on.

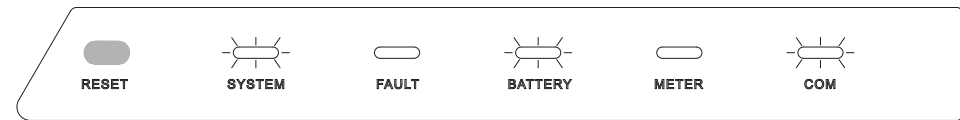

Check the wiring of the backup load  
 Switch on the external AC breaker between the load and the inverter. Please connect a low-power electrical appliance to the socket of backup load. If the electrical appliance can work normally, it means that the wiring of the backup has been installed successfully.

**NOTICE**  
 During commissioning, if the LED indicators on the display panel of the inverter or the battery pack show red, please refer to Section 10.2 for troubleshooting.

### 9.3 Powering Off the Product

**! DANGER**  
 After the inverter and battery pack is powered off, the remaining electricity and heat may still cause electric shocks and body burns. Therefore, put on protective gloves and operate the product 5 minutes after the power-off.

#### Procedure

1. Long press the power button for 6 seconds on the left side of battery pack, then switch off the battery breaker on the right side of battery pack.
2. Switch off the battery breaker which is at the bottom middle inverter.
3. Switch off the PV switch at the bottom left of the inverter.
4. Switch off the PV switch between the PV string and the inverter if there is any.
5. Switch off the AC breaker between the inverter and the load.
6. Switch off the AC breaker between the inverter and the grid.

10.1 Routine Maintenance

Normally, the inverter and battery pack need no maintenance or calibration. However, in order to maintain the accuracy of the SOC, it is recommended to perform a full charge calibration for SOC (charging battery until the charging power is 0) on the battery at regular intervals (such as two weeks)  
 Disconnect the inverter and battery pack from all power sources before cleaning. Clean the housing, cover and display with a soft cloth.  
 To ensure that the inverter and battery pack can operate properly in the long term, you are advised to perform routine maintenance on it as described in this chapter.

Maintenance checklist

Check Item	Acceptance Criteria	Maintenance Interval
Product cleanliness	The heat sinks of the inverter are free from obstacles or dust.	Once every 6 to 12 months
Product visible damage	The inverter and battery pack are not damaged or deformed.	Once every 6 months
Product running status	1. The inverter and battery pack operate with no abnormal sound. 2. All parameters of the inverter and battery pack are correctly set. Perform this check when the inverter and battery pack is running.	Once every 6 months
Electrical connections	1. Cables are securely connected. 2. Cables are intact, and in particular, the cable jackets touching the metallic surface are not scratched. 3. Unused PV input terminals and COM ports of the inverter, and battery power and COM terminals are locked by watertight caps if the product is mounted outdoor.	Perform the first maintenance 6 months after the initial commissioning. From then on, perform the maintenance once every 6 to 12 months.



**CAUTION**

**Risk of burns due to hot heatsink and housing of the inverter**  
 The heatsink and housing can get hot during operation.

- ★ During operation, do not touch any parts other than the cover of the inverter.
- ★ Wait approx. 30 minutes before cleaning until the heatsink has cooled down.

10.2 Troubleshooting









10.2.1 Inverter Error Troubleshooting

Error No.	Error description	Solution
100000	Grid_OVP	1. Check whether Grid is abnormal. 2. Confirm whether the grid cable connection is normal. 3. Restart inverter and ensure whether the fault is existing.
100001	Grid_UVP	
100002	Grid_OFP	
100003	Grid_UFP	
100005	BUS_OVP1	Restart inverter and ensure whether the fault is existing.
100006	BUS_OVP2	
100008	GFCI_fault	
100009	Leakage current test failure	
100010	Grid relay fault	1. Check whether the environment around inverter is with poor heat dissipation. 2. Confirm whether inverter installation meet the installation requirements.
100011	Over_Temperature	
100014	M_S_com_fault	
100038	Output DC over current	
100043	Output_overload	1. Check whether Backup load is overload. 2. Restart inverter and confirm whether the fault is existing.
100044	APU UVP	Restart System and ensure whether the fault is existing.
100046	DC_Input_Disturbance	
100047	Grid disturbance	1. Check whether Grid is abnormal. 2. Confirm connection of grid cable is normal. 3. Restart inverter and ensure whether the fault is existing.
100048	Grid_unbalance	
100049	Frequency jitter	
100050	Grid_overcurrent	



Error No.	Error description	Solution
100051	Grid_current_track_fault	Restart inverter and ensure whether the fault is existing.
100052	Backup_ovp	1. Check whether Backup port cable is normal. 2. Restart inverter and confirm whether the fault is existing.
100053	Dc_bus_unbalancevolt	Restart inverter and ensure whether the fault is existing.
100054	Dc_bus_undervolt	
100055	Dc_bus_unbalancevolt2	
100056	IGBT_over_current	Restart inverter and ensure whether the fault is existing.
100057	Grid_disturbance2	1. Confirm whether Grid is distorted severely. 2. Check whether PV cable connection is reliable.
100058	AFCI_check_protect	1. Check whether PV cable connection is reliable. 2. Check whether PV cable is damaged.
100059	Grid_current_sampling_abnormal	1. Confirm whether Grid is distorted severely. 2. Check whether PV cable connection is reliable.
100060	Dsp_selfcheck	Restart inverter and ensure whether the fault is existing.
100061	Grid_short_time_over_current	1. Confirm whether Grid is distorted severely. 2. Check whether PV cable connection is reliable.
100062	Bat_overnvolt_hardware_fault	1. Check whether battery breaker has tripped off. 2. Check whether battery is damaged.

### 10.2.2 Battery Protection Description

LED Indicator	Protection Code	LED Display	Description	Troubleshooting
Yellow LEDs flash once a second.	1		Temperature difference	Wait for automatic recovery. If the problem is not solved yet, please call the service center.
	3		High temperature	Stop discharging and charging until this code is eliminated and wait for the temperature to drop.
	4		Low-temperature discharge	Stop discharging until this code is eliminated and wait for the temperature to rise.
	5		Over-current charge	Wait for automatic recovery. If the problem is not solved yet, please call the service center.
	6		Over-current discharge	
	8		Cell overvoltage	
	9		Cell under voltage	
	11		Low-temperature charge	Stop charging until this code is eliminated and wait for the temperature to rise.

### 10.2.3 Battery Error Description

LED Indicator	Error Code	LED Display	Description	Troubleshooting
Red LEDs flash once a second.	Error 01		Hardware error	Restart the batteries. In case the problem is not resolved, call for service.
	Error 03		Hardware error	
	Error 05		Hardware error	
	Error 06		Circuit Breaker Open	Close circuit breaker after shutting down the battery.
	Error 08		LMU Disconnect (slave)	Reconnect the BMS communication cable.
	Error 09		SN missing	Call for service.
	Error 10		LMU Disconnect (master)	Reconnect the BMS communication cable.
	Error 11		Software version inconsistent	Call for service.
	Error 12		Multi master	Restart all batteries within 30s
	Error 13		MOS overtemperature	Power off the battery and power on the battery after 30~40 minutes.
	Error 14		Insulation fault	Restart battery and In case the problem is not resolved, call for service.
	Error 15		Total voltage fault	Restart battery and In case the problem is not resolved, call for service.



**NOTE:**

In the case of work mode, when the protection code NO. 9 appears, please quickly push the Power button 5 times in 10 seconds to force the BMS start up the MOSFET of discharging. Thus the open-circuit voltage of the battery will be detected by the inverter and get charged.

### 11.1 Removing the Product

#### Procedure

- Step 1** Power off the product by following the instructions in section 9.3 Powering Off the Product.
- Step 2** Disconnect all cables from the product, including communication cables, PV power cables, battery cables, AC cables, and PE cables.
- Step 3** Remove the WiFi module from the inverter.
- Step 4** Remove the inverter from the mounting bracket.  
Remove the Battery pack from the mounting bracket.
- Step 5** Remove the mounting bracket.

### 11.2 Packing the Product

If the original packaging is available, put the battery pack or inverter inside it and then seal it using adhesive tape.

If the original packaging is not available, put the battery pack or inverter inside a suitable cardboard box and seal it properly.

### 11.3 Disposing of the Product

If the battery pack or inverter service life expires, dispose of it according to the local disposal rules for electrical equipment and electronic component waste.

Dispose of the packaging and replaced parts according to the rules at the installation site where the device is installed.

Do not dispose the inverter and the battery pack with normal domestic waste.

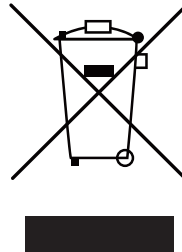

### 12.1 Datasheet of Hybrid Inverter SMILE-T10-HV-INV

Item	SMILE-T10-HV-INV (OUTDOOR)	SMILE-T10-HV-INV (INDOOR)
<b>Input DC (PV side)</b>		
Recommended max. PV power	16000 W	
Max. PV input voltage	1000 V	
Rated voltage	600 V	
Start-up voltage	160 V	
MPPT voltage range	200 ~ 850 V	
Max. input current	26 A / 26 A	
Max. short circuit current	39A / 39 A	
Inverter max. backfeed current to the array	0 A	
MPPT number/Max input strings number	2 / 4	
<b>Battery</b>		
Battery Type	Li-ion	
Battery Voltage range	240 ~ 288 V	
Maximum Charging Power	10 kW	
Maximum Charge/ discharge current	40 A / 40 A	
Communication	CAN	
<b>Output AC (Back-up)</b>		
Rated output power	10 kW	
Max. apparent output power	10 kVA	
Back-up switch time	<10 ms	
Rated output voltage	L1/ L2/ L3/N/PE, 220/380 V, 230/400 V	
Rated frequency	50/60 HZ	
Rated output current	16.7 A	
THDv(@linear load)	2%	
<b>Input AC (Grid side)</b>		
Rated Input voltage range	L1/ L2/ L3/N/PE, 220/380 V, 230/400 V	
Frequency range	45~55 Hz / 55~65 Hz	
Rated input power	15 kW	

Max. input current	22 A
<b>Output AC(Grid side)</b>	
Rated output power	10 kW
Max. apparent output power	10 kVA
Operation phase	Three phase
Rated grid voltage	L1/ L2/ L3/N/PE, 220/380 V, 230/400 V
The grid voltage range	320 ~ 480 V
Rating grid frequency	50 / 60 Hz
AC grid frequency range	47~52 Hz / 57~62 Hz
Rating grid output current	16.7 A
Max. output current	16.7 A
Max output overcurrent protection	32Arms
Power Factor	>0.99 (0.8 leading - 0.8 lagging)
THDi	<2%
Protection class/ Over voltage category	I / III
<b>Efficiency</b>	
Max efficiency	>98.4%
EU efficiency	>97.7%
<b>Protection</b>	
Anti-islanding protection	Integrated
Insulation Resistor detection	Integrated
Residual current monitoring unit	Integrated
Output over current protection	Integrated
Output short protection	Integrated
Output over voltage protection	Integrated
DC reverse polarity protection	Integrated
PV overvoltage protection	Integrated
Battery reverse protection	Integrated

PV switch	Integrated
Battery breaker	Integrated
<b>General data</b>	
Dimensions(W*H*D)	580*606*230 mm
Weight	30 kg
Topology	Transformerless
Operation temperature range	-25 ~ +60 °C
Ingress protection	IP65
Noise emission	<30 dB(A)
Cooling concept	Natural convection
Max. operation altitude	3000 m
Grid connection standard	G98 or G99, VDE-AR-N 4105 / VDE V 0124, EN 50549-1,VDE 0126 / UTE C 15/VFR:2019, RD 1699/RD 244 / UNE 206006 /UNE206007-1, CEI 0-21, C10/11,NRS 097-2-1, TOR, EIFS 2018.2, IEC 62116, IEC 61727,IEC 60068, IEC 61683, EN 50530, MEA, PEA
Safety/EMC standard	IEC62040-1, IEC62109-1/-2.AS3100, NB/T 32004, EN61000-6-2, EN61000-6-3
<b>Features</b>	
DC connection	MC4 connector
AC connection	Terminal block
Communication	LAN, WiFi (optional)
Warranty	5 years standard

### 12.2 Datasheet of Battery Pack SMILE-BAT-8.2PH

Item	SMILE-BAT-8.2PH (OUTDOOR)	SMILE-BAT-8.2PH (INDOOR)
Battery Type	LFP (LiFePO4)	
Weight	88 kg	72 kg
Dimension (W*H*D)	580*820*213 mm	580*730*200 mm
Ingress protection	IP65	IP21
Warranty	5 Year Product Warranty, 10 Year Performance Warranty	
Energy Capacity	8.2 kWh	
Usable Capacity	7.8 kWh	
Depth of Discharge (DoD)	95%	
Nominal Voltage	256 V	
Operating Voltage Range	240~288 V	

Max. Charging/Discharging Current	1.2C (38.4 A)	1C (32 A)
Operating Temperature Range*	0~49°C( Charging mode) / -10~49°C(Discharging mode)	
Relative Humidity	0% ~ 95%	15% ~ 85%
Monitoring Parameters	System voltage, current, cell voltage, cell temperature, PCBA temperature	
Communication	CAN and RS485 compatible	
Safety	IEC62619(Cell), IEC 62619(Pack)	
Transportation	UN38.3	

\* During low temperature and high temperature, the battery performance will be derating.

### Appendix 1: Communication Connection Figure

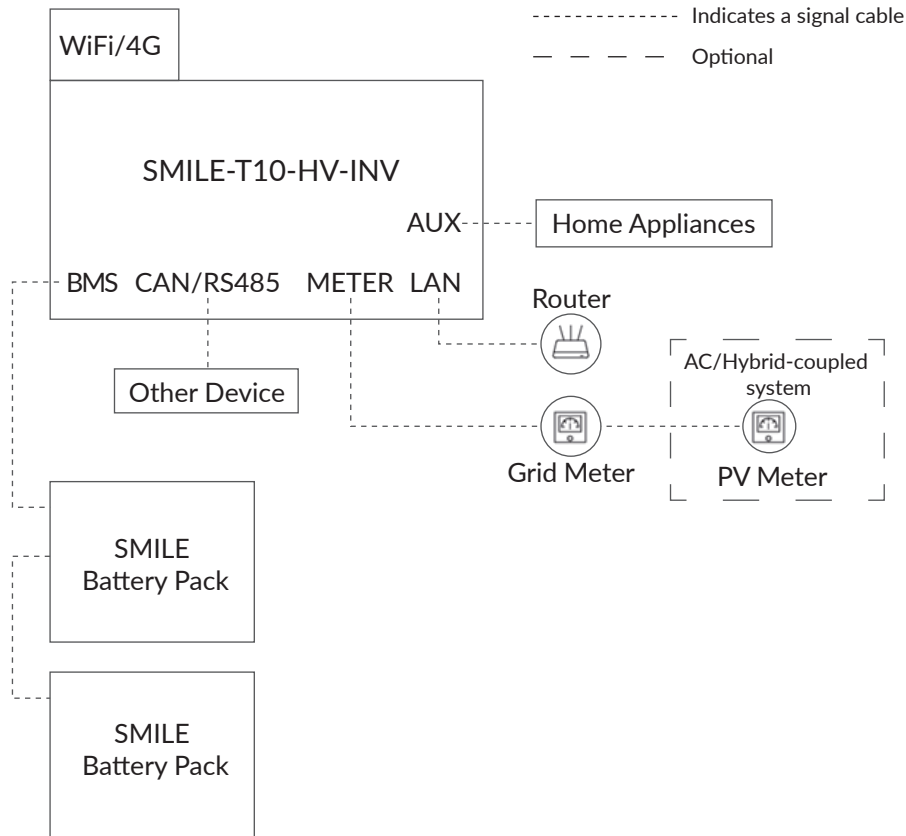

### NOTICE

- If the extra PV inverter is not used, the system is suitable for DC mode.
- If you have the extra PV inverter, the system is suitable for AC or Hybrid mode.

### Appendix 2: Regional Application Standard

Choose the correspond Regional Application Standard, the power quality modes Volt-var and Volt-Watt will run automatically (only for regions with AS/NZW 4777.2 safety regulations).

Regional application Standard	Electric Company
Australia A	N/A
Australia B	N/A
Australia C	N/A
Victoria	Ausnet Services
	Jemena
	Citipower
	Powercor
Queensland	United Energy
	Energex
South Australia	Ergon Energy
	SA Power Networks
New South Wales	Ausgrid
	Endeavour Energy
	Essential Energy
Western Australia	Horizon Power
	Western Power
Australian Capital Territory	Evoenergy
Northern Territory	NT Power and Water
Tasmania	Tas Networks
New Zealand	Vector